

APPROVAL SPECIFICATION

PRODUCT NAME:Common Mode Choke

KOOMAG PN:KMCC0805N-2- 801T01

CUSTOMER PN:

CUSTOMER RESPONSE

<input type="checkbox"/> Approval <input type="checkbox"/> Approval with the following changes <input type="checkbox"/> Reject		
APPROVED BY	SIGNATURE	DATE

KOOMAG ENGINEERING SIGNATURE

APPROVED BY	CHECKED BY	ISSUED BY
DATE	DATE	DATE

深圳坤磁科技有限公司
SHENZHEN KOOMAG TECHNOLOGY CO., LTD

Address: B503, Building B, HuaChuangDa Headquarters Building, Bao'an 49 District, Shenzhen

KMCC0805N-2-801T01

General Description

1. This specification applies to the KMCC0805 series of Common Mode Choke.10/100/1000MHz Ethernet Application.
2. It does not adversely affect the transmission signal of the LAN and suppresses unnecessary common mode noise.
3. Operating Temperature Range : -40 ~ +105 °C ,Storage condition : Temperature -10 ~ +40 °C, Relative humidity 40%~60%.

Appearance & Shape

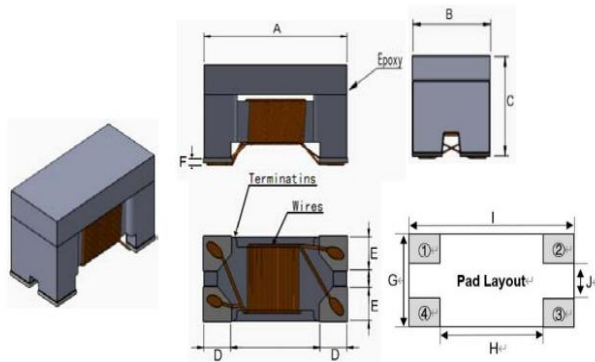

Dimension (Unit:mm)

Series:	KMCC0805N-2- 801T01
A (mm)	2.0±0.2
B (mm)	1.2±0.2
C (mm)	1.20±0.2
D (mm)	0.45±0.1
E (mm)	0.50±0.1
F (mm)	0.15±0.05
G (mm)	1.40
H (mm)	1.20
I (mm)	2.6
J (mm)	0.4

Part Number

KMCC	0805	N	-	2	-	801	T	01
A	B	C		D		E	F	G

- A:Series
- B:Dimension
- C:Material
- D:Number of Lines
- E:Impedance
- F:Taping and Reel
- G:Control

Equivalent Circuit / Materials

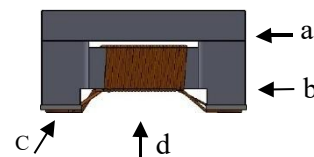
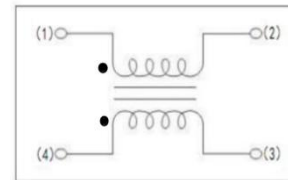

NO.	Description	Specification
a	Upper Plate	Ferrite
b	Core	Ferrite Core
c	Termination	Ag/Ni/Sn
d	Wire	Enameled Copper Wire

Electrical Characteristics

Part No.	Common mode Impedance (Ω)	DC Resistance (Ω) max.	Test Frequency (MHz)	Rated Volt. (Vdc)max.	Rated Current (mA)max.	Withstand Volt. (Vdc)max.	IR (Ω)min.
KMCC0805N-2-801T01	800 \pm 25%	0.88	100	50	300	125	10M

Curve Frequency(MHz)

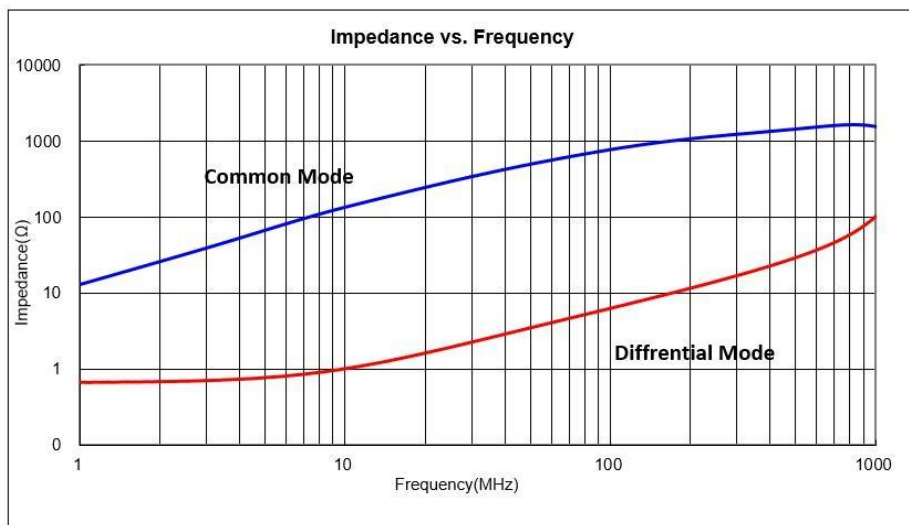

General Reflow Profile & Iron Soldering

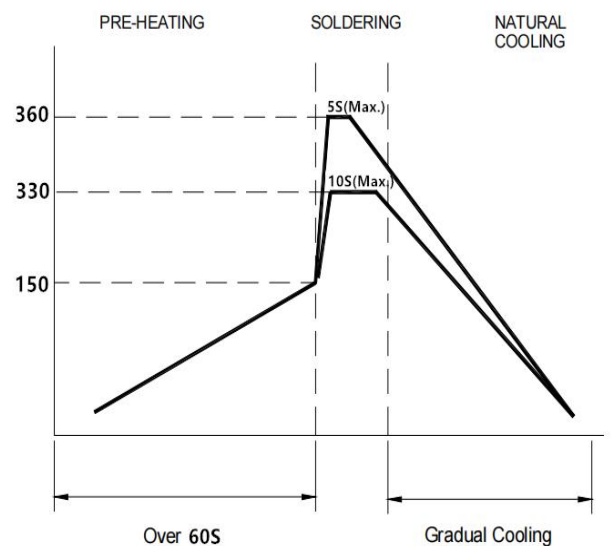
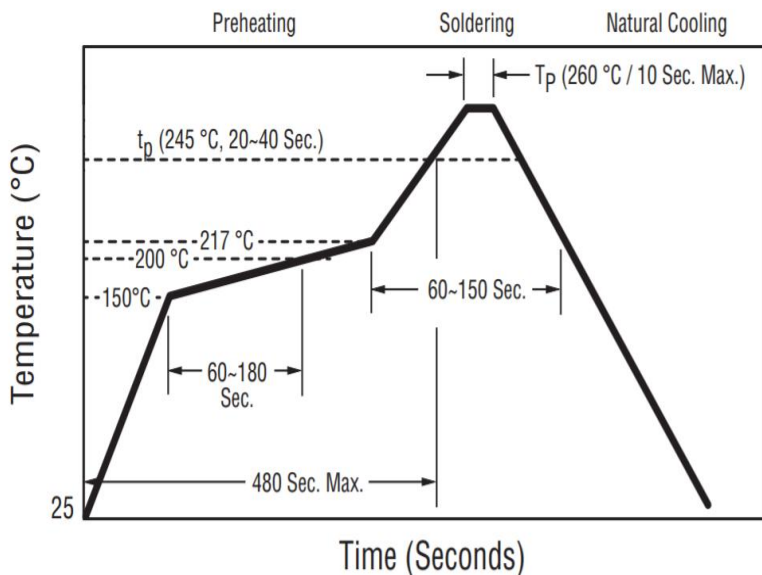

Packaging

(1) Tape Dimensions(Unit:mm)

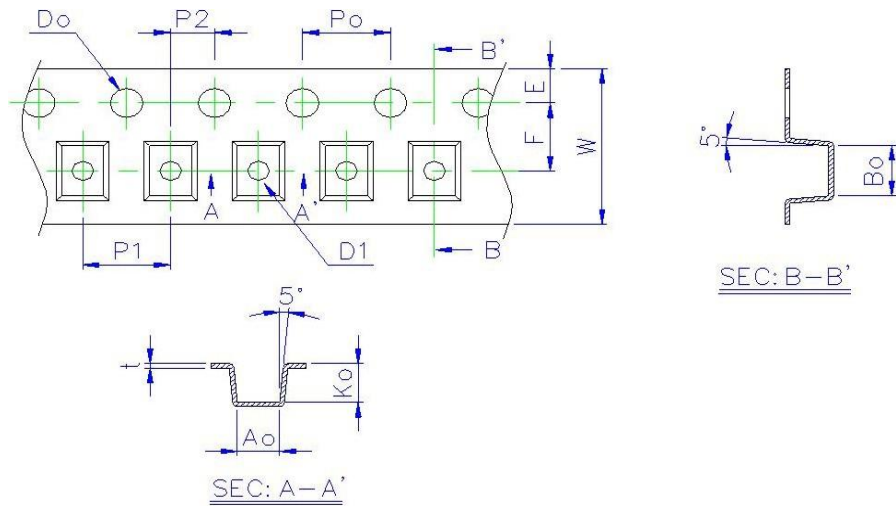

Size	Ao(mm)	Bo(mm)	Ko(mm)	W(mm)	E(mm)	F(mm)	Po(mm)	P1(mm)	Do(mm)
KMCC0805	2.35±0.10	1.50±0.10	1.45±0.10	8.00±0.20	1.75±0.10	3.50±0.05	4.0±0.05	4.0±0.10	1.5+0.1,-0

(2) Reel

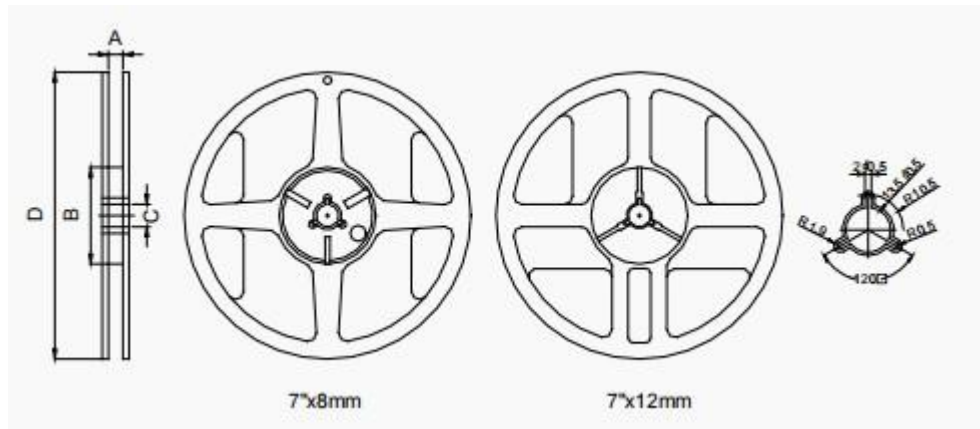

Type	A(mm)	B(mm)	C(mm)	D(mm)
7"x8mm	9.0±0.5	60±2	13.5±0.5	178±2
7"x12mm	13.5±0.5	60±2	13.5±0.5	178±2

Part No.	Tape	MPQ
KMCC0805N-2-801T01	Embossed Tape	2000PCS